

FRESHBOX 100 WiFi



**Single-room
heat recovery unit**

**Air flow up to 59 CFM
Heat recovery efficiency up to 96 %**





FRESHBOX 100 WiFi

SINGLE-ROOM AIR HANDLING UNITS

Features

- Efficient solution for supply and exhaust ventilation of enclosed spaces.
- Low-energy EC fans.
- Silent operation.
- Supply air purification ensured by two built-in MERV8 and MERV14 filters (optionally HEPA filter).
- Upgradeable with an exhaust duct to provide air extraction from the bathroom.
- Easy installation.
- Compact size.
- Wi-Fi communication
- Controlled by Android or iOS smartphone or tablet.

 **Air flow:**
up to **59 CFM**
28 l/s

 **Heat recovery efficiency:**
up to **96 %**



Design

- Polymer coated metal casing decorated with an acrylic front panel. Heat and noise insulation is ensured by a layer of 10 mm cellular synthetic rubber.
- The front panel provides convenient access for filter maintenance and has a lock for extra security.
- The unit has two Ø3 15/16" pipes for fresh air intake and stale air extraction outside. The third Ø3 15/16" pipe (included in the scope of delivery) can be additionally fitted to the unit to connect the exhaust air duct from the bathroom.

Fans

- The units feature efficient electronically commutated (EC) motors with an external rotor and impellers with forward curved blades. These state-of-the-art motors are the most advanced solution in energy efficiency today.
- EC motors are characterised with high performance and optimum control across the entire speed range. In addition to that the efficiency of electronically commutated motors reaches very impressive levels of up to 90 %.

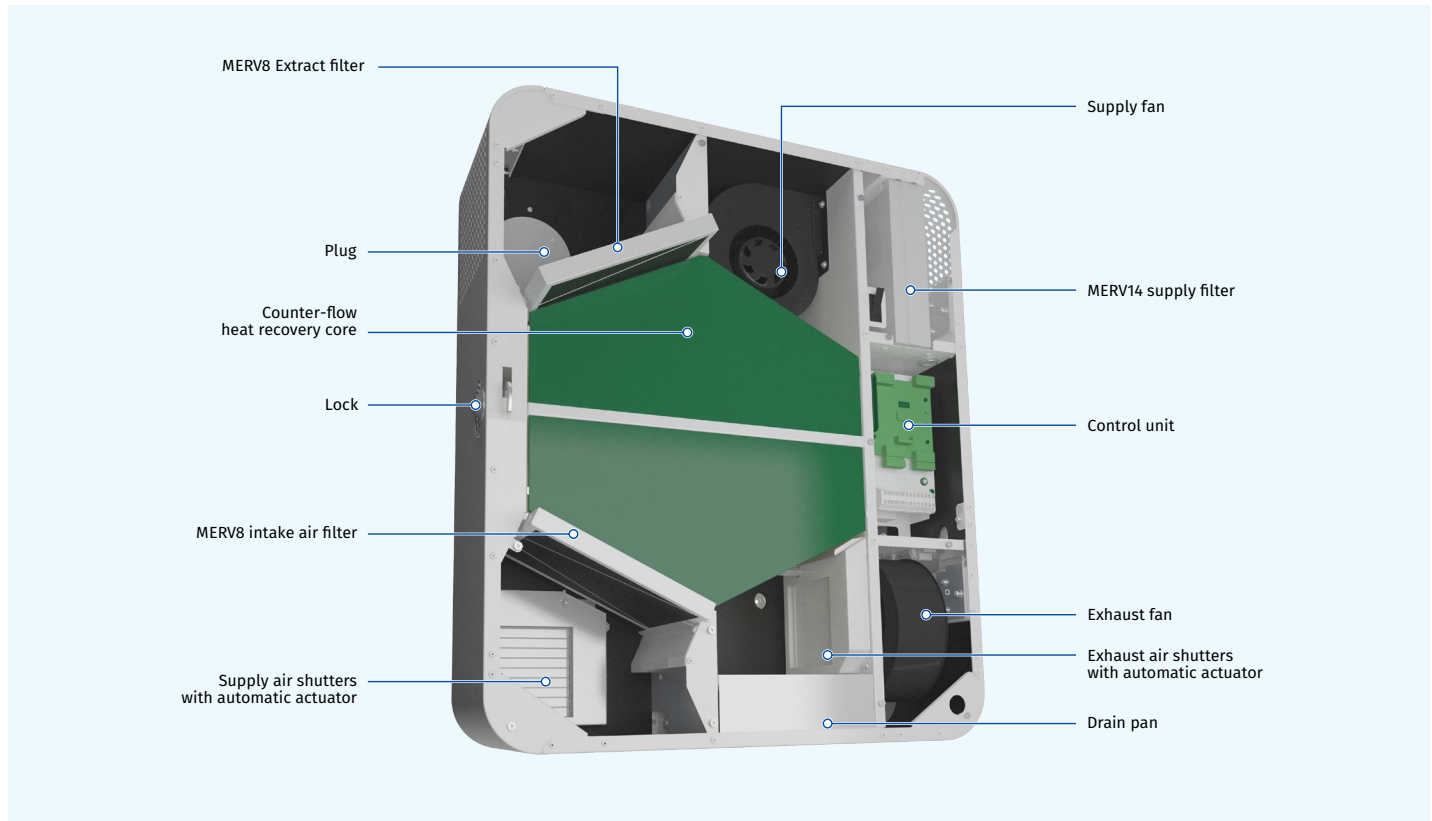

Designation key

Model	Nominal air flow [m³/h]	Heat exchanger core type	Control
Freshbox	100	.: standard type ERV: enthalpy type	WiFi: Wi-Fi communication

FRESHBOX 100 WiFi

SINGLE-ROOM AIR HANDLING UNITS

Air dampers

- The unit is equipped with supply and exhaust air dampers which activate automatically to prevent drafts while the unit is off.

Air filtration

- Supply air cleaning is provided by the MERV8 and MERV14 panel filters (PM2.5 > 75 %). To meet more stringent air purity requirements the MERV14 filter can be replaced with an HEPA Filter type C (PM2.5 > 95 %) (purchased separately). Exhaust air is cleaned by the panel filter MERV8.

Operating principle

- The cold outdoor air passes through the filters and the heat exchanger and then is delivered to the serviced space by the supply centrifugal fan.
- Warm stale air from indoors passes through the filter and the heat exchanger and is discharged outdoors by the centrifugal fan.
- The supply and exhaust air flows are fully separated which helps eliminate the possibility of odour or microbial transfer between the streams.

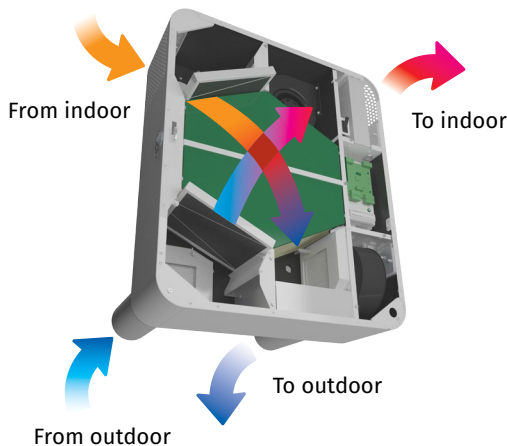

Operating principle with extra spigot for bathroom exhaust ventilation

Heat and energy recovery

- The **Freshbox 100 WiFi** units are equipped with a counter-flow heat recovery core with a polystyrene core.
 - In the cold season the exhaust air heat is captured and transferred to the supply air stream which reduces the ventilation-generated heat losses.
 - Some condensate may form during heat recovery. The condensate is collected in the drain pan and is removed from the exhaust air duct.
 - In the warm season the intake air heat is transferred to the extract air stream. This allows for a considerable reduction of the supply air temperature which, in turn, reduces the air conditioning load.

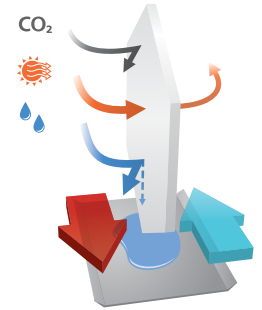

- The **Freshbox 100 ERV WiFi** units are equipped with a counter-flow energy recovery core with an enthalpy membrane at the core.
 - In the cold season the exhaust air heat and moisture are transferred to the supply air stream through the enthalpy membrane reducing the heat losses through ventilation.
 - Consequently, it is the intake air heat and moisture transferred to the extract air stream through the enthalpy membrane in the warm season. This allows for a considerable reduction of the supply air temperature and humidity which, in turn, reduces the air conditioning load.

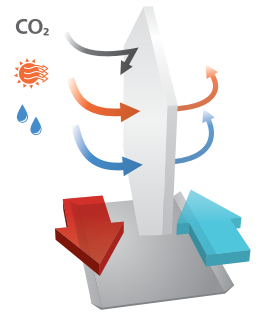

Control

- The unit is equipped with a control panel.
- The remote control is supplied as standard.
- Wi-Fi communication
- Controlled by Android or iOS smartphone or tablet.



FUNCTIONS

- Speed changeover
- Filter replacement indication
- Alarm indication
- Speed setting
- Timer
- Weekly schedule

FREEZE PROTECTION

- **Freshbox 100 (ERV) WiFi** features an exhaust air temperature sensor downstream of the heat exchanger which disables the supply fan to let the warm extract air warm up the heat exchanger. After that the supply fan is turned on and the unit reverts to the normal operation mode.

FRESHBOX 100 WiFi

SINGLE-ROOM AIR HANDLING UNITS

Technical data

Parameters	Freshbox 100 WiFi			Freshbox 100 ERV WiFi		
	I	II	III	I	II	III
Speed						
Voltage [V / 50 (60) Hz]	1~120					
Max. power [W]	20	29	53	20	29	53
Max. current consumption [A]	0.4					
Maximum air flow [CFM (l/s)]	18 (8)	35 (17)	59 (28)	18 (8)	35 (17)	59 (28)
SFP [W/l/s]	1.44	1.26	1.62	1.44	1.26	1.62
RPM [min ⁻¹]	max 2200					
Sound pressure level at 10 ft [dBA]	13	27	39	13	27	39
Transported air temperature [°F]	-13...+122					
Casing material	polymer coated steel					
Insulation thickness [in]	3/8"					
Extract filter	MERV8					
Supply filter	MERV8 + MERV14 (Option: MERV14 Carbon; HEPA Filter type C)					
Connected air duct diameter [in]	4"					
Weight [lb]	68.3					
Heat recovery efficiency [%]*	96	92	87	90	86	80
Heat recovery core type	counter-flow					
Heat recovery core material	polystyrene			enthalpic membrane		
SEC class	A					

*Heat recovery efficiency is specified in compliance with EN 13141-8.

Sound power level, A-filter applied.

Sound-power level, A - weighted	General	Octave frequency band [Hz]								Sound pressure level at 10 ft, A-filter applied	Sound pressure level at 3 ft, A-filter applied
		63	125	250	500	1000	2000	4000	8000		
L _{WA} to environment [dBA]	4000	45	40	44	38	33	29	27	22	28	38

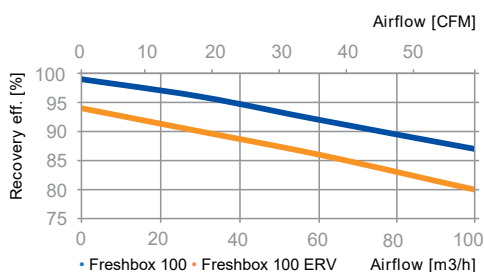
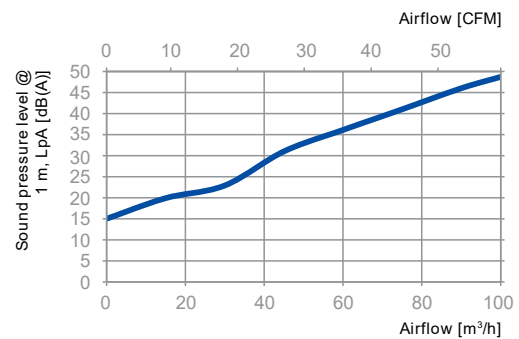
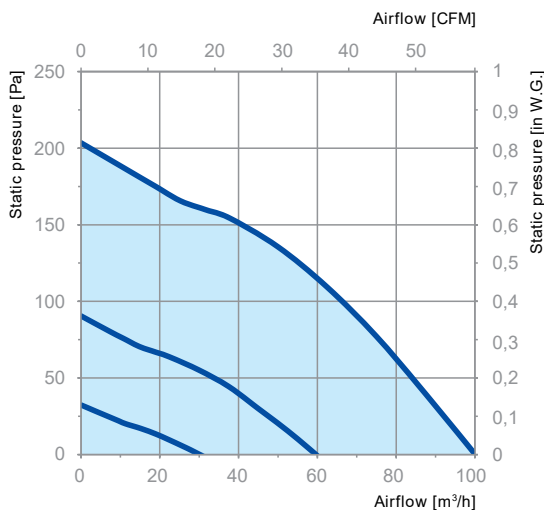



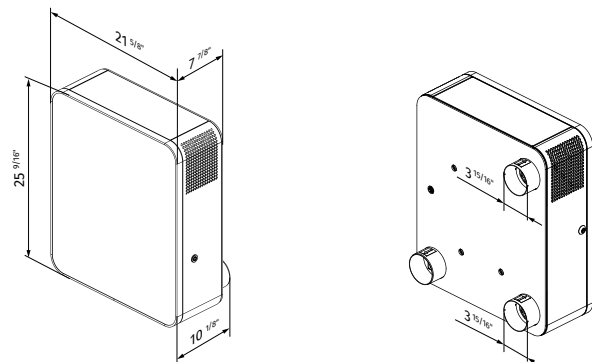









Overall dimensions [in]



FRESHBOX 100 WiFi

SINGLE-ROOM AIR HANDLING UNITS

Accessories

Name		Description
MS Freshbox 100 chrome		Mounting kit: Two Ø 3 15/16" mm air ducts, 500 mm long Ventilation outer hood made of polished steel Cardboard template
MS Freshbox 100 white		Mounting kit: Two Ø 3 15/16" mm air ducts, 500 mm long Ventilation outer hood, painted white Cardboard template
AH Freshbox 100 chrome		Ventilation outer hood made of polished steel.
AH Freshbox 100 white		Ventilation outer hood, painted white
EH Freshbox 100		Heater to prevent condensate freezing in the drain pipe and outer ventilation hood
FP 193x158x18 G4 PPI		MERV8 Filter
FP 193x158x47 F8		MERV14 Filter
FP 193x158x47 F8 C		MERV14 Carbon Filter
FP 193x158x47 H13		HEPA Filter type C
HR-S		Humidity sensor
CD-1		CO ₂ Sensor with LED lights for indication of CO ₂ concentration and a touch button for operation mode switching
CD-2		CO ₂ Sensor

Blauberg Ventilatoren
174 N. 36th Street
Lafayette, IN 47905
tel.: +1 765 780 7139

info@blauberg.us
www.blauberg.us
www.blaubergventilatoren.de

Technical changes reserved.
Illustrations and texts are non-binding.